



Oregon Department of Forestry
 2600 State St Salem OR 97310
 PART III: EXHIBITS

EXHIBIT B
TIMBER SALE OPERATIONS PLAN
 (See page 2 for instructions)

Date Received by State: _____

(5) State Brand Information (Complete)

(1) Contract Number: TL-341-2024-W01037-01

(2) Sale Name: King of Diamonds

(3) Contract Expiration Date: 10/31/2027

(4) Purchaser Name: _____

(6) State Representatives:

<u>Name</u>	<u>Circle One</u>	<u>Phone No.</u>	<u>Cell No.</u>	<u>Alt Phone</u>
	Logging Projects All			
	Logging Projects All			
	Logging Projects All			
	Logging Projects All			

(7) Purchaser Representatives:

<u>Name</u>	<u>Circle One</u>	<u>Phone No.</u>	<u>Cell No.</u>	<u>Alt Phone</u>
	Logging Projects All			
	Logging Projects All			
	Logging Projects All			
	Logging Projects All			
	Logging Projects All			
	Logging Projects All			
	Logging Projects All			

(8) Name of Subcontractors and Start Dates:

<u>Project No.</u>	<u>Subcontractor Name.</u>	<u>Start Date</u>	<u>Completion Date</u>	<u>Cell No.</u>	<u>Alt Phone</u>

	<u>Subcontractor Name.</u>	<u>Start Date</u>	<u>Cell No.</u>	<u>Alt Phone</u>
FELLING				
YARDING				

(9) Comments:

(10) Operations Map: Attach a copy of timber sale Exhibit A or other suitable map which plainly shows the items listed on the instruction sheet.



Oregon Department of Forestry

2600 State St Salem OR 97310

PART III: EXHIBITS

EXHIBIT B

INSTRUCTION SHEET FOR OPERATIONS PLAN

SUBMIT ONE COPY OF PLAN STATE

Operations shall be limited to the work shown in the plan until a revised plan or supplemental plan is submitted covering additional work. Compliance with this plan is not in lieu of compliance with any federal requirements related to the federal Endangered Species Act including without limitation PURCHASER'S independent obligation to avoid take of a T&E species and PURCHASER'S obligation to comply with terms and conditions of any incidental take Permit(s) that include required minimization and mitigation measures in any applicable Habitat Conservation Plan. If STATE has prepared a required Forest Practices Act (FPA) "Written Plan" for operations, PURCHASER shall comply with all provisions of the Written Plan.

Explanation of Item No.(from Page 1)

- (5) All sales require you to use a brand furnished by STATE. If the State brand has not been assigned when the plan is submitted, it will be furnished and assigned later. Complete drawing. If more than one brand is assigned to the sale, complete both drawings.
- (6) The contract requires you to have a designated representative available on the sale area or work location who is authorized to receive in your behalf any notice or instruction given by STATE and to take action in regard to performance under the contract. If logging and project work is widely separated, a representative is required for each.
- (7) The STATE representative will be designated when your plan is approved and is the person who will inspect and issue instructions regarding performance.
- (8) Show names of subcontractors to be used for any or all phases of the operations. If subcontractors are not Known, or are changed later, give notification to the STATE representative prior to commencement of work by subcontractor.
- (9) Show projected dates for commencement of both projects and logging. If projected dates need to be changed at a later date, notification must be given to the STATE representative by supplemental plan or otherwise, prior to commencement of such operations.
- (10) The STATE representative will furnish extra copies of Exhibit A of the contract for your use in preparing the operations map. The map shall use the following legend and show:
 1. Landing locations, approximate setting boundaries, and probable sequence of logging the settings. Number the settings in sequence.
 2. Locations of spur roads planned for construction, other than required by the timber sale contract. Provide spur road specifications
 3. Locations of proposed tractor yarding roads. Show if and how marked on the ground.
 4. Locations of temporary stream crossings.
 5. List the sequence of performing project work.
 6. Location of rock sources - attach pit development plans.

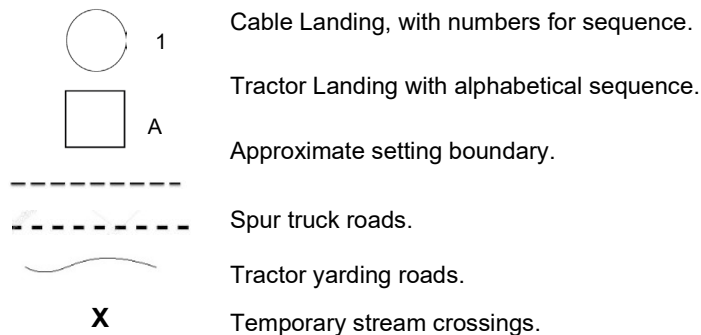



Oregon Department of Forestry
 2600 State St Salem OR 97310
 PART III: EXHIBITS
EXHIBIT B
OPERATIONS PLAN

Completion Timeline

Indicate on the appropriate timeline below, the dates by which you plan to complete the work as required under this contract. The purpose of this section is to develop a plan that will ensure you complete the work as required, and meet the interim completion date(s) and contract expiration date. This plan is incorporated and made a part of the contract. When, in the opinion of STATE, operations are not commencing in a manner that meets the intent of this plan, you may be placed in violation of contract and your operations suspended until an amended plan is submitted and approved by STATE.

Projects

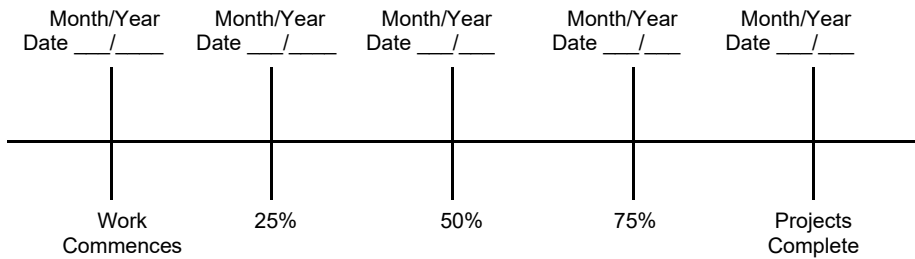

Harvest & Other Requirements

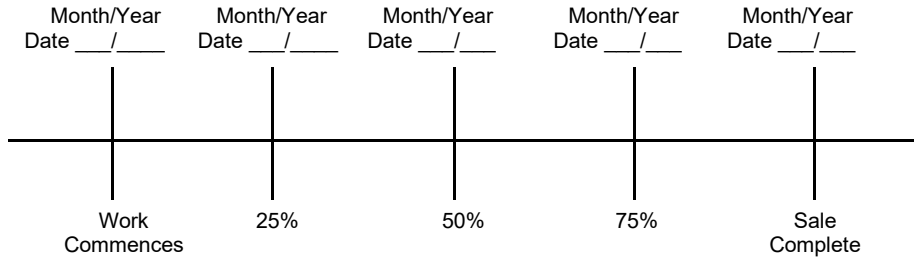

The Federal Endangered Species Act (ESA) prohibits a person from taking any federally listed threatened or endangered species. Taking under the federal ESA may include alteration of habitat. STATE's approval of this plan does not certify that PURCHASER's operation under the plan is lawful under the federal ESA or that the plan is consistent with the terms and conditions of any applicable incidental take Permit(s) including any required minimization and mitigation measures proposed in the applicable Habitat Conservation Plan. As provided in the timber sale contract, PURCHASER's must comply with all applicable state, federal, and local laws, including without limitation any Permit(s) issued thereunder.

PURCHASER's compliance with this plan is not in lieu of compliance with any federal requirements related to the federal Endangered Species Act.

APPROVED; Date: _____

SUBMITTED BY:
PURCHASER

STATE OF OREGON - DEPARTMENT OF
FORESTRY

Title _____

Title _____



Oregon Department of Forestry
EXHIBIT C - SAWMILL GRADE (WESTSIDE SCALE)
SCALING INSTRUCTIONS - LOCATION APPROVAL - BRAND INFORMATION
 Tillamook - NWOA

(1) ORIGINAL REGISTRATION Date _____
 REVISION NUMBER 000 Date _____
 CANCELLATION Date _____

(2) TO: _____
 (Third Party Scaling Organization)

(3) FROM: Tillamook Phone (503) 842-2545
 (State Forestry District)

Address: 5005 THIRD ST
 TILLAMOOK, OR 97141-2999

(4) PURCHASER: _____

Mailing Address: _____

Phone Number: _____

(5) MINIMUM SCALING SPECIFICATIONS	
SPECIES	MINIMUM NET VOLUME
Conifers	10
Hardwoods	10

*Apply minimum volume test to whole logs over 40' Westside

(6) WESTSIDE SCALE:
 Use Region 6 actual taper rule. Logs over 40'.

YES NO

(7) Weight Scale Sample YES NO

(8) APPROVED SCALING LOCATIONS <small>(as shown on the ODF Approved Locations web-site)</small>	Species	Yard	Truck	Weight

(9) SALE NAME: King of Diamonds
 COUNTY: Tillamook

(10) STATE CONTRACT NUMBER:
 TL-341-2024-W01037-01

(11) STATE BRAND REGISTRATION NUMBER:

(12) STATE BRAND INFORMATION:

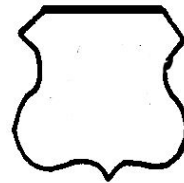

(13) PAINT REQUIRED: YES
 COLOR: Orange

(14) SPECIAL REQUESTS (Check applicable)	
PEELABLE CULL (all species).....	<input checked="" type="checkbox"/>
NO DEDUCTIONS ALLOWED FOR MECHANICAL DAMAGE	<input checked="" type="checkbox"/>
ADD-BACK VOLUME - Deductions due to delay...	<input checked="" type="checkbox"/>
OTHER :	

(15) REMARKS:
 "Mule Trains"
 1. Loads are required to have load tickets for each set of bunks.
 2. If truck and pup are to be weighed, weigh and process separately for gross and tare weights.

Operator's Name (Optional inclusion by District): _____

(16) SIGNATURES:

 Purchaser or Authorized Representative Date

 State Forester Representative Date

 State Forester Representative PRINT NAME

Notify the District within one hour when branding or painting is inadequate for quick identification, the receipts are missing, not correctly or completely filled out, and/or when logs presented for scaling are impossible to scale accurately.
 General Distribution: TPSO, Approved Scaling Locations and Purchaser.



Oregon Department of Forestry
EXHIBIT C - SAWMILL GRADE
INSTRUCTIONS FOR EXHIBIT C
Tillamook - NWOA

(1) Check appropriate box. REVISION NUMBER requires comments. CANCELLATION requires logging and hauling to be complete, recall branding hammers.

(2) Designate Third Party Scaling Organization (TPSO).

Columbia River Log Scaling & Grading Bureau
P.O.Box 7002, Eugene, OR 97401
Phone: (541) 342-6007 Fax: (541) 342-2631
Email: services@crls.com

Pacific Rim Log Scaling Bureau, Inc.
8288 28th Court North East, Lacey, WA 98516
Phone: (360) 528-8710 Fax: (360) 528-8718
Email: office@prlsb.com

Mountain Western Log Scaling & Grading Bureau
2560 NW Medical Park Drive, OR 97471
Phone: (541) 673-5571 Fax: (541) 672-6381
Email: info@mwlsgb.com

Yamhill Log Scaling & Grading Bureau
P.O.Box 709, Forest Grove, OR 97116
Phone: (503) 359-4474 Fax: (503) 359-4476
Email: yamhilllog@frontier.com

Northwest Log Scalers Inc.
6137 NE 63rd St, Vancouver, WA, 98661
Phone: (360) 553-7212 ext. 4 Fax:(360) 553-7213
Email: info@nwlogscalers.com

(3) State District office, address and phone.

(4) Enter Purchaser's business name, address, and phone number as it appears on the Contract.

(5) Minimum Scaling Specifications.

(6) Westside - Region 6 actual taper segment scale. Check Yes or No. Special Service Rules on file with TPSO. See: Segment Scaling and Grading of Long Logs - All Species - State Forestry Department Scaling Practices (Westside).

(7) Weight Scale Sample - Check box if sale is to be a Weight Scale Sample. All specifies for handling, scaling and processing will be attached or explained in the Remarks section item (15).

(8) Show scaling locations only applicable to TPSO. Location name should appear as it does on the ODF Approved Scaling Location web site: https://apps.odf.oregon.gov/Divisions/management/asset_management/scalinglocation.asp Locations with scaling and processing directions specific to their location should be on a separate form. Species should be identified if not capable of receiving "all" species. Check appropriate box for either: yard, truck scale, or weight. Refer to the web site listed above for the locations approval status.

(9) Enter sale name and county.

(10) Enter sale Contract number.

(11) Enter Oregon's State Brand Registry Number (**REQUIRED**).

(12) Show brand assigned to timber sale. One brand only. If more than one brand is assigned to the sale: (1) make a separate form for each brand and (2) on each form, explain and show other brand(s) in the Remarks section item (15).

(13) Check yes for Paint Required and designate "Orange" for color. Non required removal volumes may sometimes require blue paint.

(14) Special Requests. These are requests that will be applied to ODF timber sales. All boxes applicable to the timber sales designated in the Exhibit C form must be "marked". If "Other" is indicated, it must contain a description and any necessary comments.

(15) Use this space to designate any weight scale sample instructions or any other explanations to clarify scaling, processing and/or mailing requirements. If additional scaling locations are approved, revise original or current form showing all (old and new) locations. Check REVISION box at top of form and explain under remarks. Route as indicated.

(16) Require purchaser to sign and date completed form in addition to State Forester Representative, sign and print name on the form. Signatures not required on revisions.



**Oregon Department of Forestry
 EXHIBIT C - PULP SORT
 PROCESSING INSTRUCTIONS - LOCATION APPROVAL
 BRAND INFORMATION**

Tillamook, NWOA

(1) ORIGINAL REGISTRATION Date _____
 REVISION NUMBER 000 Date _____
 CANCELLATION Date _____

(2) TO: _____
 (Approved Pulp Processing Facility)

(3) FROM: Tillamook Phone (503) 842-2545
 (State Forestry District)
 Address: 5005 THIRD ST
TILLAMOOK, OR 97141-2999

(4) PURCHASER: _____

(5) Scaling Bureau (TPSO) Processing Weight receipts:

Mailing Address: _____

Phone Number: _____

(9) SALE NAME: King of Diamonds

COUNTY: Tillamook

(10) STATE CONTRACT NUMBER:
TL-341-2024-W01037-01

(11) STATE BRAND REGISTRATION NUMBER: _____

(12) STATE BRAND INFORMATION:

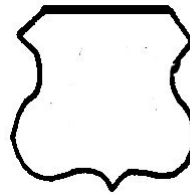

(13) REMARKS:
 "Mule Trains"
 1. Loads are required to have load tickets for each set of bunks.
 2. Truck and pup are to be weighed and processed separately for gross and tare weights.

Operator's Name (Optional inclusion by District):

(14) SIGNATURES:

 Purchaser or Authorized Representative Date

 State Forester Representative Date

 State Forester Representative PRINT NAME

(6) STATE Definition of Approved Pulp Sort:
 • Top portion of the tree (tops).
 • All logs with a diameter (Big End) greater than 8 inches marked with blue paint.

(7) PULP FACILITY PROCESSING INSTRUCTIONS:
 • Pulp loads shall be weighed in lieu of scaling.
 • One Ton = 2000 lbs (Short Ton).
 • Pulp loads shall have a yellow Log Load Receipt attached.
 • Gross weight and truck tare weight for each load shall be machine printed on the weight receipt.
 • Weigher shall sign the weight receipt.
 • Weigher shall record the Log Load Receipt number on the weight receipt.
 • Weigher shall attach the Weight receipt to the Log Load Receipt and mail them weekly to the TPSO processing the Weight receipt.

(8) TPSO PROCESSING INSTRUCTIONS
 • Submit data files daily (or each day of activity).
 • Mail or deliver scale tickets weekly to ODF Headquarters in Salem.

Notify the District within one hour when branding is inadequate for quick identification, the logs are marked with orange paint, the receipts are missing, not correctly or completely filled out, and/or logs do not meet the specifications of the STATE definition of Approved Pulp Sort.

General Distribution: TPSO, Approved Scaling Locations and Purchaser.



Oregon Department of Forestry EXHIBIT C - PULP SORT INSTRUCTIONS FOR EXHIBIT C

Tillamook, NWOA

- (1) Check appropriate box. REVISION NUMBER requires comments. CANCELLATION requires logging and hauling to be complete, recall branding hammers.
- (2) Approved Pulp Processing Facility. Write in as written in the Approved Log Delivery Location https://apps.odf.oregon.gov/Divisions/management/asset_management/scalinglocation.asp
- (3) State District office, address and phone.
- (4) Enter Purchaser's business name, address, and phone number as it appears on the Contract.
- (5) Third Party Scaling Organization that will be processing the weight tickets, mailing address, and phone number.

Columbia River Log Scaling & Grading Bureau
P.O.Box 7002, Eugene, OR 97401
Phone: (541) 342-6007 Fax: (541) 342-2631
Email: services@crls.com

Pacific Rim Log Scaling Bureau, Inc.
8288 28th Court North East, Lacey, WA 98516
Phone: (360) 528-8710 Fax: (360) 528-8718
Email: office@prlsb.com

Mountain Western Log Scaling & Grading Bureau
2560 NW Medical Park Drive, Roseburg, OR 97471
Phone: (541) 673-5571 Fax: (541) 672-6381
Email: info@mwlsgb.com

Yamhill Log Scaling & Grading Bureau
P.O.Box 709, Forest Grove, OR 97116
Phone: (503) 359-4474 Fax: (503) 359-4476
Email: yamhilllog@frontier.com

Northwest Log Scalers Inc.
6137 NE 63rd St, Vancouver, WA, 98661
Phone: (360) 553-7212 ext. 4 Fax: (360) 553-7213
Email: info@nwlogscalers.com

- (6) Big end of log is not to exceed 2 inches greater than the minimum removal specifications in the contract. Example: Minimum removal specifications 6 inches and 20 board feet, then the Big end of log not to exceed 8 inches. When conifer and hardwood removal specifications are different, use the smaller removal diameter to determine this specification.
- (9) Enter sale name and county.
- (10) Enter sale Contract number.
- (11) Enter Oregon's State Brand Registry Number **(REQUIRED)**.
- (12) Show brand assigned to timber sale. One brand only, if more than one brand is assigned to the sale: (1) make a separate form for each brand and (2) on each form, explain and show other brand(s) in the Remarks section Item (13).
- (13) Use this section to list any special instructions or the reason for any revisions in section item (1).
- (14) Require purchaser to sign and date completed form in addition to State Forester Representative, sign and print name on the form. Signatures not required on revisions.

EXHIBIT D
FOREST ROAD SPECIFICATIONS

POINT TO POINT	STATION TO STATION	SUBGRADE WIDTH (feet)	SURFACE WIDTH (feet)	DRAINAGE	DITCH SHAPE	DITCH DEMINSIONS (WIDTH X DEPTH) (feet)
A to B	0+00 to 27+45	-	14	Existing	V	3X1
A to B	27+45 to 28+60	-	14	Outslope	-	-
A to B	28+60 to 31+10	-	14	Existing	V	3X1
A to B	31+10 to 33+55	-	14	Outslope	-	-
A to B	33+55 to 40+45	-	14	Existing	V	3X1
A to B	40+45 to 42+00	-	14	Outslope	-	-
A to B	42+00 to 64+25	-	14	Existing	V	3X1
A to B	64+25 to 67+45	-	14	Outslope	-	-
A to B	67+45 to 84+50	-	14	Existing	V	3X1
A to B	84+50 to 90+15	-	14	Outslope	-	-
A to B	90+15 to 97+15	-	14	Existing	V	3X1
A to B	97+15 to 98+10	-	14	Outslope	-	-
A to B	98+10 to 137+15	-	14	Existing	V	3X1
A to B	137+15 to 282+85	-	12	Existing	V	2X1
A to B	282+85 to 291+20	-	12	Outslope	-	-
A to B	291+20 to 302+05	-	12	Ditch	V	2X1
A to B	302+05 to 336+10	-	12	Outslope	-	-
C to D	0+00 to 4+15	16	12	Outslope	-	-
E to F	0+00 to 3+65	16	12	Outslope	-	-
I to J	0+00 to 17+30	16	12	Ditch	V	2X1
K to L	0+00 to 1+75	16	12	Outslope	-	-
M to N	0+00 to 4+75	16	12	Outslope	-	-
O to P	0+00 to 39+65	-	12	Outslope	-	-
Q to R	0+00 to 5+70	16	12	Ditch	V	2X1
S to T	0+00 to 2+80	16	12	Outslope	-	-
U to V	0+00 to 20+70	16	12	Outslope	-	-
W to X	0+00 to 2+80	16	12	Outslope	-	-
Y to Z	0+00 to 1+40	16	12	Outslope	-	-
AA to BB	0+00 to 3+35	16	12	Outslope	-	-
CC to DD	0+00 to 4+10	16	12	Ditch	V	2X1
EE to FF	0+00 to 2+10	16	12	Outslope	-	-
GG to HH	0+00 to 103+40	-	12	Existing	-	-

EXHIBIT D
FOREST ROAD SPECIFICATIONS

CLEARING. This work shall consist of clearing, removing, and disposing of all trees, snags, down timber, brush, surface objects, and protruding obstructions within the clearing limits. Trees outside the clearing limits shall not be felled unless approved in writing by STATE. All danger trees, leaners, and snags outside the clearing limits which could fall and hit the road shall be felled. Where clearing limits have not been marked, clearing limits shall be as follows:

- Construction – 10 feet back from the top of the cut slope and 5 feet back from the toe of fill slopes.
- Improvements and reconstructions - 10 feet back from the shoulder of the subgrade or the ditch, whichever is widest.

GRUBBING. This work shall consist of the removal or digging out of stumps and protruding objects. All stumps shall be completely removed within the limits of required grubbing. Stumps overhanging cutslopes shall be removed. Grubbing limits shall be as follows:

- New construction - From the top of the cutslope to the toe of the fill.
- Reconstruction - 4 feet back from the shoulder of the subgrade or the ditch, whichever is widest.
- Sidecast pullback – From top of pullback to toe of pullback.

CLEARING AND GRUBBING DISPOSAL. Clearing and grubbing debris shall not be placed or permitted to remain in or under any road embankment sections. Clearing and grubbing debris shall not be left lodged against standing trees. Clearing and grubbing debris may be scattered through openings in the timber outside of the cleared right-of-way, except for the following areas where debris shall be fully contained and hauled to a designated waste area:

- Where end-haul is required
- On side slopes exceeding 55 percent
- On unstable areas
- In any stream channel (Type F, N or D) or where material may enter the stream channel.
- Grubbed stumps from cable landing construction, reconstruction

Clearing, grubbing, and associated disposal shall be completed prior to subgrade approval.

EXHIBIT D

FOREST ROAD SPECIFICATIONS

EXCAVATION. Excavation and grading shall not be done when weather and/or ground conditions are such that damage will result to existing subgrade or cause excessive erosion.

Excavation shall conform to STATE-specified lines, grades, dimensions, and plans when provided.

Suitable excavated material shall be used for the formation of fills, shoulders, and drainage structure backfills. Embankment materials shall be free of woody debris, brush, muck, sod, frozen material, and other deleterious materials. All fills and drainage structure backfills shall be machine compacted according to the "Compaction and Processing Requirements" in Exhibit E.

Unless road plans show otherwise, all roads shall be on a balanced cross section, except when the slope is over 55 percent, the road shall be on full bench for the width specified.

Sidecast includes any road generated excess excavation material which is not essential as part of the road prism, is not compacted, and is below the roadway. Sidecast shall not be placed where it will enter a stream course or where material will accumulate in areas deemed a high landslide hazard location by STATE. Leaving sidecast below the road is only permissible if specifically allowed in "Full Bench and End Haul Requirements" in this Exhibit.

All bank excavation and sidecast pullback on a project road segment shall be completed prior to subgrade approval.

ROAD WIDTH LIMITATIONS. PURCHASER shall obtain advance written approval from STATE to construct the road to a greater width than specified. Extra subgrade width shall be required for:

Fill Widening. Add to each fill shoulder 1 foot for fills 3 feet to 6 feet high; 2 feet for fills over 6 feet high.

Curve Widening. Widen the inside shoulder of all curves as specified in the road plans or as follows: 400 divided by the radius of the curve equals the amount of extra width.

DRAINAGE

Ditch. Construct ditch as specified in Exhibit D. Subgrade shall be crowned at 4 to 6 percent. Construct ditchouts away from subgrade at locations marked in the field or as directed by STATE.

Outslope. Road subgrade shall be outsloped at 4 to 6 percent.

Existing. Road subgrade and drainage shall be maintained in its current configuration, outsloped where outsloped, insloped where insloped, and ditched where ditched

TURNOUTS. Increase roadbed width an additional 8 feet for both subgrade and surfacing. Length shall be at least 25 feet, or as staked on the ground, plus 25-foot approaches at each end.

Location: Intervisible but not greater than 750 feet apart.

SLOPES

Rock
Common

Back Slopes
Vertical to 1/4 :1
3/4 :1

Fill Slopes
Not Steeper
Than 1 1/2: 1

Top of cutslopes shall be rounded.

LANDINGS. Landings shall be constructed as posted in the field, no less than 50 feet wide and no more than 70 feet wide unless otherwise approved by STATE. Surface is to be crowned for drainage with general grade no more than 4 percent and no less than 2 percent. All cuts shall be ditched. Surface the landing as shown in the "Road Surfacing" table in Exhibit E. Deposit stumps associated with landing construction/reconstruction at the designated waste area.

TURNAROUNDS. Increase subgrade width an additional 30 feet for a length of 16 feet with 20' radius returns at locations marked in the field.

SEASONAL WINTERIZATION. All unsurfaced roads or unfinished subgrades shall be waterbarred in accordance with the specifications in Exhibit H, and blocked from vehicular traffic prior to October 31, annually and as directed by STATE.

EXHIBIT D
FOREST ROAD SPECIFICATIONS
ADDITIONAL ROAD INSTRUCTIONS

A to B: Remove ravel and construct or clean existing ditches with an excavator where they do not meet the specifications in Exhibit D, spread and compact. Where side slopes are greater than 55%, endhaul to designated waste area, spread and compact. Construct or clean ditchouts and culverts where necessary.

Pullback the existing sidecast between the following stations, according to specifications in Exhibit J and as marked in the field. Haul material to designated waste area, spread and compact.

From Station	To Station	Depth(ft)	Width(ft)
160+60	161+10	8	2
191+95	192+65	14	7
202+40	203+00	15	10

Pluck trees within 10ft of road edge between stations 291+20 and 336+10. Endhaul to station 281+35, pile and burn as directed by State.

Fall or pluck all trees under 5in dbh within 15ft of road edge and all trees painted with an orange X between stations 12+85 to 95+35 and scatter outside of right-of-way.

Push waste piles up against cut bank in waste area at station 253+95.

Replace 7 damaged or missing culvert markers.

Erosion Control- Excavate material in OHV trail junctions as directed by State and as marked in the field. Install culvert in ditchline in accordance with Exhibit G and backfill culvert and trail with indicated rock.

From Station	Remove(yds)	Backfill(yds)
27+45	10	10
83+80	10	10
94+05	10	10
204+05	10	10
248+30	10	10

C to D: Max grade 20% stations 0+00 to 1+15.

I to J: Max grade 20% stations (0+35 to 5+20), (7+55 to 9+90), (12+60 to 16+75).

Construct minimum 70ft Landing at Point J.

K to L: Construct minimum 70ft Landing at Point L.

M to N: Construct minimum 60ft Landing at Point N.

Construct minimum 5ft fill at station 3+60.

O to P: Remove ravel on road and clean culverts between stations 24+00 and 39+65. Dispose of in accordance with Exhibit D and as directed by State.

Q to R: Max grade 20% stations (0+75 to 1+40), (1+95 to 3+05), (4+10 to 5+00).

Construct minimum 70ft Landing at Point R.

U to V: Repair road edge at station 15+05 with jawrun. Block trail with logs and slash from across the road.

W to X: Construct minimum 60ft Landing at Point X.

Y to Z: Construct minimum 60ft Landing at Point Z.

EXHIBIT D

FOREST ROAD SPECIFICATIONS
ADDITIONAL ROAD INSTRUCTIONS

CC to DD: Max grade 25% stations (0+55 to 2+30).

Construct minimum 70ft Landing at Point DD.

EE to FF: Construct minimum 70ft Landing at station 0+95 and Point FF.

GG to HH: Remove ravel and construct or clean existing ditches with an excavator where they do not meet the specifications in Exhibit D, spread and compact. Where side slopes are greater than 55%, endhaul to designated waste area, spread and compact. Construct or clean ditchouts and culverts where necessary.

Pullback the existing sidecast between the following stations, according to specifications in Exhibit J and as marked in the field. Haul material to designated waste area, spread and compact.

From Station	To Station	Depth(ft)	Width(ft)
9+15	9+35	6	4
84+20	85+65	12	7
94+05	94+45	12	2
96+20	96+40	10	3

Use rock hammer to remove boulder at station 96+20

EXHIBIT D

ROAD BRUSHING SPECIFICATIONS
REQUIREMENTS

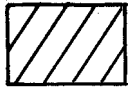

Clearing Limits

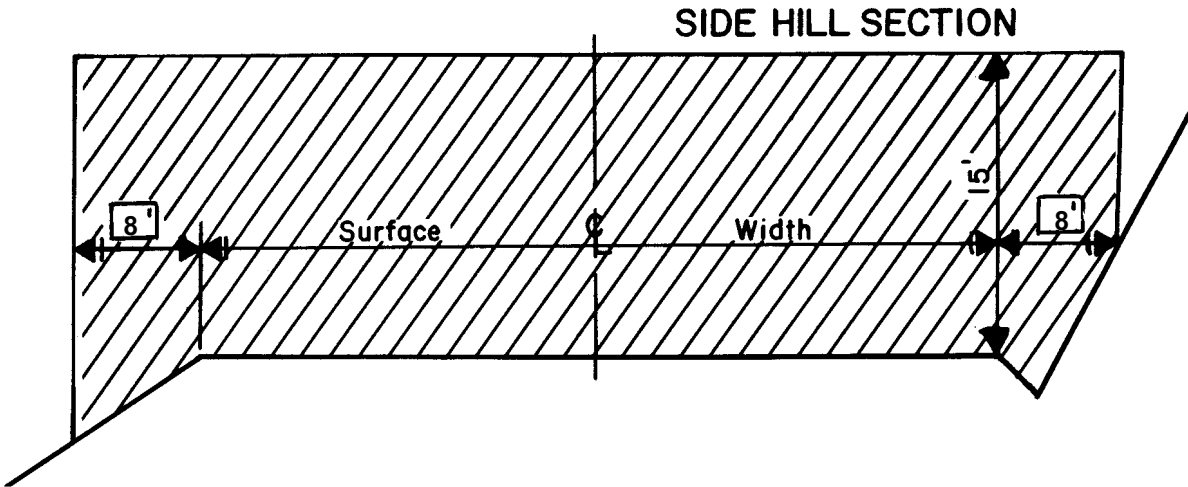

Unless otherwise approved in writing by STATE, brush and trees less than 8 inches DBH shall be cut to a height of 6 inches or less above the ground surface or obstructions such as rocks or existing stumps. Trees 8 inches or larger in diameter at stump height shall not be felled but shall be limbed for road visibility. Brushing on project road segments shall be completed prior to subgrade approval. Trees shall not be felled unless a portion of the bole is within the clearing limits.

When spur roads to be brushed end with a Landing, the Landing is to be brushed as directed by STATE.

At stream crossings brushing shall extend 14ft from the edge of the roadway on both sides in the draw.

Debris resulting from the brushing operation shall be removed from the roadway, cutslope, ditches, water courses, culvert inlet and outlets, and sediment catch basins within 72 hours and may be scattered downslope from the road or placed in other stable locations, unless otherwise approved by STATE.

Trees outside the clearing limits shall not be felled unless approved in writing by STATE.

CULVERT AND ROAD MARKER DAMAGES. Culvert and road markers damaged, or any portion of a marker damaged from PURCHASER activities shall be repaired or replaced by PURCHASER.

EXHIBIT D
FULL BENCH AND END-HAUL REQUIREMENTS

POINT TO POINT	STA. TO STA.
A to B	48+10 to 73+35
A to B	97+15 to 104+85
A to B	137+15 to 211+20
A to B	257+45 to 334+65
I to J	13+20 to 14+20
I to J	16+30 to 17+30
O to P	24+00 to 39+65
CC to DD	All
EE to FF	All
GG to HH	All

Full Bench and End-Haul Areas General Requirements

Sidecast includes any road generated excess excavation material which is not essential as part of the road prism, is not compacted, and is below the roadway. Material shall not be sidecast unless specified above.

Clearing and grubbing debris shall be end-hauled.

When controlled blasting is required, it shall be accomplished using timing devices, delayed charges, low intensity shots, or other suitable means to contain material within the road prism.

Containment/Sidecast

Full Containment: Sidecast material lost over the outside edge of the road shall not exceed 6 inches in depth, measured perpendicular to the natural ground slope. Pioneer excavation shall be removed by digging, loading, and hauling rather than by pushing or scraping methods.

Tree bases and stumps may have up to 12 inches of material directly above them.

Any amount of material exceeding the containment requirements shall be removed by whatever means necessary and end-hauled to a designated waste area.

Waste Area Location

- (1) As shown on Exhibit A and as marked in the field.
- (2) Setback from slope break shall be a minimum of 20 feet horizontal measurement.
- (3) Where side slopes are less than 55% and more than 75ft from non-fish bearing streams.

Waste Area Treatment

- (1) Deposit at waste area, spread evenly, compact, and provide adequate drainage.
- (2) Pile woody debris separate from other waste material.
- (3) Mulch and seed all waste areas in accordance with Exhibit N.
- (4) No tree felling outside of harvest units is allowed.

EXHIBIT E

ROAD SURFACING

ROAD SEGMENT:		A to B		STATIONS:		0+00 to 336+10			
Application	Rock Size and Type	Location	Compacted Depth	Volume (CY) per		Number of Units	Curve Widening (CY)	Approx. Total (CY)	
Road Rock	Crushed 1.5"-0"	257+45 to 271+00	3 "	station	15	13.55	10	210	
Road Rock	Jawrun 4"-0"	282+85 to 336+10	9 "	station	50	53.25	120	2,780	
Road Rock	Crushed 1.5"-0"	291+20 to 302+60	3 "	station	15	11.40	10	180	
Turnouts	Crushed 1.5"-0"	A to B	3 "	TO	10	2	20		
Turnouts	Jawrun 4"-0"	A to B	9 "	TO	20	8	160		
Turnouts	Crushed 1.5"-0"	A to B	3 "	TO	10	2	20		
Application	Rock Size and Type	Location	Approx. Total (CY)						
Spot Rock	Crushed 2"-0"	As Directed	200						
Landing Rock	Jawrun 4"-0"	334+65	100						
Trail Hardening	Jawrun 4"-0"	27+45	10						
Energy Dissipator	Rip rap 12"-6"	40+45	5						
Trail Hardening	Jawrun 4"-0"	83+80	10						
Energy Dissipator	Rip rap 12"-6"	88+00	5						
Trail Hardening	Jawrun 4"-0"	94+05	10						
Energy Dissipator	Rip rap 12"-6"	100+80	5						
Energy Dissipator	Rip rap 12"-6"	120+55	5						
Energy Dissipator	Rip rap 12"-6"	130+50	5						
Trail Hardening	Jawrun 4"-0"	204+05	10						
Energy Dissipator	Rip rap 12"-6"	210+40	5						
Trail Hardening	Jawrun 4"-0"	224+10	10						
Trail Hardening	Jawrun 4"-0"	248+30	10						
Culvert Backfill	Crushed 2"-0"	25yds each	150						

ROAD SEGMENT:		C to D		STATIONS:		0+00 to 4+15			
Application	Rock Size and Type	Location	Compacted Depth	Volume (CY) per		Number of Units	Curve Widening (CY)	Approx. Total (CY)	
Road Rock	Jawrun 4"-0"	0+00 to 1+00	9 "	station	50	1.00	10	60	
Application	Rock Size and Type	Location	Approx. Total (CY)						
Intersection Widening	Jawrun 4"-0"	0+00	30						
Culvert Backfill	Jawrun 4"-0"	2+60	200						

EXHIBIT E

ROAD SURFACING

ROAD SEGMENT:		E to F		STATIONS:		0+00 to 3+65			
Application	Rock Size and Type	Location	Compacted Depth	Volume (CY) per		Number of Units	Curve Widening (CY)	Approx. Total (CY)	
Road Rock	Jawrun 4"-0"	0+00 to 3+65	9 "	station	49	3.65	10	190	
Turnouts	Jawrun 4"-0"	E to F	9 "	TO	20	1		20	
Application	Rock Size and Type	Location	Approx. Total (CY)						
Intersection Widening	Jawrun 4"-0"	0+00	30						
Landing Rock	Jawrun 4"-0"	3+85	60						
Turnaround	Jawrun 4"-0"	1+45	30						

ROAD SEGMENT:		I to J		STATIONS:		0+00 to 17+30			
Application	Rock Size and Type	Location	Compacted Depth	Volume (CY) per		Number of Units	Curve Widening (CY)	Approx. Total (CY)	
Road Rock	Jawrun 4"-0"	0+00 to 17+30	9 "	station	50	17.30	40	910	
Road Rock	Crushed 1.5"-0"	0+35 to 5+20	2 "	station	10	4.85	10	60	
Road Rock	Crushed 1.5"-0"	7+55 to 9+90	2 "	station	13	2.35	10	40	
Turnouts	Jawrun 4"-0"	I to J	9 "	TO	20	3		60	
Turnarounds	Jawrun 4"-0"	0+00	9 "	TA	30	1		30	
Application	Rock Size and Type	Location	Approx. Total (CY)						
Intersection Widening	Jawrun 4"-0"	0+00	30						
Energy Dissipator	Rip rap 12"-6"	5yds each	10						
Landing Rock	Jawrun 4"-0"	17+30	70						

ROAD SEGMENT:		K to L		STATIONS:		0+00 to 1+75			
Application	Rock Size and Type	Location	Compacted Depth	Volume (CY) per		Number of Units	Curve Widening (CY)	Approx. Total (CY)	
Road Rock	Jawrun 4"-0"	0+00 to 1+75	9 "	station	51	1.75	10	100	
Turnarounds	Jawrun 4"-0"	0+00	9 "	TA	30	1		30	
Application	Rock Size and Type	Location	Approx. Total (CY)						
Intersection Widening	Jawrun 4"-0"	0+00	30						
Landing Rock	Jawrun 4"-0"	1+75	70						

EXHIBIT E

ROAD SURFACING

ROAD SEGMENT:		M to N		STATIONS:		0+00 to 4+75			
Application	Rock Size and Type	Location	Compacted Depth	Volume (CY) per		Number of Units	Curve Widening (CY)	Approx. Total (CY)	
Road Rock	Jawrun 4"-0"	0+00 to 4+75	9 "	station	51	4.75	20	260	
Turnouts	Jawrun 4"-0"	M to N	9 "	TO	20	1		20	
Turnarounds	Jawrun 4"-0"	0+00	9 "	TA	30	1		30	
Application	Rock Size and Type	Location	Approx. Total (CY)						
Intersection Widening	Jawrun 4"-0"	0+00	30						
Landing Rock	Jawrun 4"-0"	0+00	60						

ROAD SEGMENT:		O to P		STATIONS:		0+00 to 39+65			
Application	Rock Size and Type	Location	Approx. Total (CY)						
Spot Rock	Crushed 2"-0"	As Directed	20						

ROAD SEGMENT:		Q to R		STATIONS:		0+00 to 5+70			
Application	Rock Size and Type	Location	Compacted Depth	Volume (CY) per		Number of Units	Curve Widening (CY)	Approx. Total (CY)	
Road Rock	Jawrun 4"-0"	0+00 to 5+70	9 "	station	51	5.70	20	310	
Road Rock	Crushed 1.5"-0"	0+75 to 1+40	2 "	station	8	0.65	10	15	
Road Rock	Crushed 1.5"-0"	1+95 to 3+05	2 "	station	14	1.10	10	25	
Turnouts	Jawrun 4"-0"	Q to R	9 "	TO	20	1		20	
Turnarounds	Jawrun 4"-0"	0+00	9 "	TA	30	1		30	
Application	Rock Size and Type	Location	Approx. Total (CY)						
Traction Rock	Crushed 1.5"-0"	4+10	20						
Intersection Widening	Jawrun 4"-0"	0+00	30						
Curve Widening	Jawrun 4"-0"	1+40	20						
Curve Widening	Jawrun 4"-0"	3+40	20						
Landing Rock	Jawrun 4"-0"	5+70	70						

EXHIBIT E

ROAD SURFACING

ROAD SEGMENT:		S to T		STATIONS:		0+00 to 2+80			
Application	Rock Size and Type	Location	Compacted Depth	Volume (CY) per	Number of Units	Curve Widening (CY)	Approx. Total (CY)		
Road Rock	Jawrun 4"-0"	0+00 to 2+80	9 "	station 50	2.80	30	170		
Application	Rock Size and Type	Location	Approx. Total (CY)						
Intersection Widening	Jawrun 4"-0"	0+00	30						
Intersection Widening	Jawrun 4"-0"	2+80	30						

ROAD SEGMENT:		U to V		STATIONS:		0+00 to 20+70			
Application	Rock Size and Type	Location	Approx. Total (CY)						
Spot Rock	Crushed 2"-0"	As Directed	20						
Spot Rock	Jawrun 4"-0"	15+05	10						

ROAD SEGMENT:		W to X		STATIONS:		0+00 to 2+80			
Application	Rock Size and Type	Location	Compacted Depth	Volume (CY) per	Number of Units	Curve Widening (CY)	Approx. Total (CY)		
Road Rock	Jawrun 4"-0"	0+00 to 2+80	9 "	station 50	2.80	10	150		
Turnouts	Jawrun 4"-0"	W to X	9 "	TO 20	1		20		
Application	Rock Size and Type	Location	Approx. Total (CY)						
Intersection Widening	Jawrun 4"-0"	0+00	30						
Landing Rock	Jawrun 4"-0"	2+80	60						

ROAD SEGMENT:		Y to Z		STATIONS:		0+00 to 1+40			
Application	Rock Size and Type	Location	Compacted Depth	Volume (CY) per	Number of Units	Curve Widening (CY)	Approx. Total (CY)		
Road Rock	Jawrun 4"-0"	0+00 to 1+40	9 "	station 50	1.40	10	80		
Application	Rock Size and Type	Location	Approx. Total (CY)						
Intersection Widening	Jawrun 4"-0"	0+00	30						
Landing Rock	Jawrun 4"-0"	1+40	60						

ROAD SEGMENT:		AA to BB		STATIONS:		0+00 to 3+35			
Application	Rock Size and Type	Location	Compacted Depth	Volume (CY) per	Number of Units	Curve Widening (CY)	Approx. Total (CY)		
Road Rock	Jawrun 4"-0"	0+00 to 1+00	9 "	station 50	1.00	10	60		

EXHIBIT E

ROAD SURFACING

ROAD SEGMENT:		CC to DD		STATIONS:		0+00 to 4+10			
Application	Rock Size and Type	Location	Compacted Depth	Volume (CY) per		Number of Units	Curve Widening (CY)	Approx. Total (CY)	
Road Rock	Jawrun 4"-0"	0+00 to 4+10	9"	Station	51	4.10	10	220	
Road Rock	Crushed 1.5"-0"	0+55 to 2+30	2"	station	11	1.75	10	30	
Turnouts	Jawrun 4"-0"	CC to DD	9"	TO	20	1		20	
Turnarounds	Jawrun 4"-0"	0+00	9"	TA	30	1		30	
Application	Rock Size and Type	Location	Approx. Total (CY)						
Intersection Widening	Jawrun 4"-0"	0+00	30						
Energy Dissipator	Rip Rap 12"-0"	0+55	5						
Landing Rock	Jawrun 4"-0"	4+10	70						

ROAD SEGMENT:		EE to FF		STATIONS:		0+00 to 2+10			
Application	Rock Size and Type	Location	Compacted Depth	Volume (CY) per		Number of Units	Curve Widening (CY)	Approx. Total (CY)	
Road Rock	Jawrun 4"-0"	0+00 to 2+10	9"	station	52	2.10	10	120	
Turnouts	Jawrun 4"-0"	EE to FF	9"	TO	20	1		20	
Application	Rock Size and Type	Location	Approx. Total (CY)						
Intersection Widening	Jawrun 4"-0"	0+00	30						
Landing Rock	Jawrun 4"-0"	0+95	70						
Landing Rock	Jawrun 4"-0"	2+10	70						

ROAD SEGMENT:		GG to HH		STATIONS:		0+00 to 103+40			
Application	Rock Size and Type	Location	Approx. Total (CY)						
Spot Rock	Crushed 2"-0"	As Directed	50						
Culvert Backfill	Crushed 2"-0"	84+60	20						
Energy Dissipator	Rip Rap 12"-6"	84+60	5						
Culvert Backfill	Crushed 2"-0"	95+95	20						
Energy Dissipator	Rip Rap 12"-6"	95+95	5						
Energy Dissipator	Rip Rap 12"-6"	83+10	5						
Energy Dissipator	Rip Rap 12"-6"	94+25	5						

TOTAL ROCK	12"-6" Riprap	4"-0" Jaw-run	2"-0" Crushed	1 1/2"-0 Crushed
8,525CY	65CY	7,360CY	480CY	620CY

EXHIBIT E

ROCK SPECIFICATIONS

Roads shall be uniformly graded and approved by STATE prior to rocking. Additional rock for curve widening is required and has been included in the volume estimates. Turnouts, turnarounds, landings and junctions shall be rocked concurrently with the road. End-dumping of riprap shall not be allowed, unless otherwise approved in writing by STATE. Any additional turnarounds or turnouts created during any operation associated with this timber sale shall be rocked at PURCHASER's expense and as instructed by STATE.

For typical cross section, turnout and turnaround see Forestry Department Drawing Nos. 351-C, 351-D and TOTA-1 at the Forestry Department district office.

Materials. The material shall be fragments of rock crushed to the required size. The material shall be free from vegetation and lumps of clay. STATE may require screening and/or rejecting of materials utilized for production of crushed rock for the purpose of removing excess fine material. Excess fines are present, when greater than 5 percent of a total rock sample weight, passes a #200 sieve. Rock crushing shall be limited to periods when weather conditions are acceptable to STATE.

Quality and Grading Requirements. The base material shall be rock. River gravel shall not be used.

For the purpose of crushing rock specified under the projects in Section 2610, "Project Work," PURCHASER shall utilize a jaw with screen rock crusher, or equivalent, unless otherwise approved by STATE.

The rock crusher shall be calibrated to produce rock as specified in this exhibit. Prior to the commencement of production crushing, PURCHASER shall sample, test, and provide rock test results meeting STATE specifications. Any rock crushed prior to STATE approval to proceed shall not be credited to the required rock quantity. Any subsequent rock tests not meeting STATE specifications shall be reason for rejection of that portion of rock produced after that test and shall not be credited to the required rock quantity. STATE may sample the rock at any time during the operation. Results of STATE's tests shall prevail over all other test results.

EXHIBIT E

CRUSHED ROCK SPECIFICATIONS

<u>For 4"-0" Jawrun</u>	Passing	4" sieve	95%
	Passing	2" sieve	40-60%
	Passing	¼ " sieve	10% maximum

For 12"-6" Rip rap 50 percent or more of the material shall measure at least 12 inches in one dimension. Material shall be clean, well graded, and free of 2"-0" fines.

Control of rip rap and pitrun gradation shall be by visual inspection by STATE. Pitrun shall be reasonably free of organic material and shall not contain an excessive amount of oversized (cobbles or boulders) or undersized (clay, silt or sand) particles.

The referenced sieve shall have square openings as set forth in AASHTO M 92, Woven Cloth Series. The determinations of size and gradings shall be as set forth in AASHTO T 27.

ROCK ACCOUNTABILITY

PURCHASER shall obtain subgrade approval from STATE prior to rocking. Rocking shall be limited to periods when weather conditions are acceptable to STATE and when sediment will not enter streams. Additional surfacing needed because of construction season or construction practice is not included in the preceding ROAD SURFACING table, and shall be furnished at PURCHASER expense.

Rock accountability shall be determined by the following methods, as directed by STATE. STATE shall be given 24 hours' notice prior to rocking.

Depth Measurement. Rock shall be spread and compacted according to the depths specified in Exhibit E. Truck measure volumes are given, but shall not limit the amount of rock spread. Depth shall be determined in the most compacted area of the surface cross section. The depth of compacted aggregates shall not vary more than 1 inch from the depth specified in the "Road Surfacing" table in Exhibit E. The average depth for each road segment shall be the specified depth or greater. If additional rock is required because of insufficient depth, the locations and volumes to be added shall be determined by STATE. The conversion from compacted yardage to truck yardage is 1.3 multiplied by the compacted yardage equals truck yardage

Landings, Junctions, Turnouts, Turnarounds, and Heliports shall have a minimum rock volumes as shown in Exhibit E and visual inspections by STATE.

Curve Surfacing. Extra surface width shall be required for the inside of all curves as follows: 400 divided by the radius of the curve equals the amount of extra width to be surfaced at the depths shown in Exhibit E.

EXHIBIT E

COMPACTION AND PROCESSING REQUIREMENTS

Moisture Content: Compaction must take place when moisture content of the materials being compacted is favorable for effective compaction as determined by STATE.

Compaction Pass: A pass is defined as traveling a road section forward and then backward over that same section.

Subgrade. Subgrade surfaces of the road segments listed below shall be graded and compacted prior to rocking. Compaction shall be accomplished by traveling all surfaces from shoulder to shoulder until the surface is smooth and hard and visible deformation ceases. At least 3 passes shall be made over the entire width and length of the road. Compaction shall be accomplished by using one or more of the approved equipment options listed below:

Subgrade shall be crowned or outsloped at 4 to 6 percent as specified in the “Forest Roads Specifications” table in Exhibit D.

ROAD SEGMENT	COMPACTION EQUIPMENT OPTIONS
All	Vibratory Roller

Fills. Embankments and fills shall be placed in approximately horizontal layers not more than 8 inches in depth. Each layer shall be separately, and thoroughly, compacted. Compaction equipment shall be operated over the entire width of each layer until visible deformation of the layers ceases. At least 3 passes shall be made over the entire width and length of each layer.

Placing individual rocks or boulders with more depth than the allowed layer thickness shall be permitted, provided the embankment will accommodate them. Such rocks and boulders shall be at least 6 inches below the subgrade. They shall be carefully distributed and the voids filled with finer material, forming a dense and compacted mass. Compaction shall be accomplished by using one or more of the approved equipment options listed below:

ROAD SEGMENT	COMPACTION EQUIPMENT OPTIONS
Culvert Backfills	Vibratory Hand-Operated or Backhoe-Mounted Tamper
All Other Fills	Vibratory Roller

Crushed Rock. The rock shall be uniformly mixed and spread in layers on the approved roadbed. Each layer of crushed rock shall be moistened or dried to uniform moisture content suitable for maximum compaction and compacted in layers not to exceed 6 inches in depth. When more than 1 layer is required, each shall be shaped, compacted, and approved by STATE before the succeeding layer is placed. Any irregularities or depressions that develop during compaction of the top layer shall be corrected by loosening the material at these places and adding or removing material until the surface is smooth and uniform. Each layer shall be compacted with a minimum of 3 passes over the entire width and length of the road until the surface is smooth and hard and visible deformation ceases. Compaction shall be accomplished by using one or more of the approved equipment options listed below:

Rock shall be compacted and processed during the same project period it is spread, unless otherwise approved in writing by STATE.

Rock shall be crowned or outsloped at 4 to 6 percent as specified in the “Forest Roads Specifications” table in Exhibit D.

ROAD SEGMENT	COMPACTION EQUIPMENT OPTIONS
All	Vibratory Roller

EXHIBIT E

COMPACTION AND PROCESSING REQUIREMENTS

Existing Crushed Rock. The existing rock shall be unearthed to a minimum depth of 4 inches or to 1 inch below the bottom of potholes, whichever is greater. The existing rock shall then be uniformly mixed and moistened or dried to a uniform moisture content suitable for maximum compaction and compacted. Any irregularities or depressions that develop during compaction shall be corrected by loosening the material at these places and adding or removing material until the surface is smooth and uniform. The existing rock shall be compacted with a minimum of 3 passes over the entire width and length of the road. Compaction shall be accomplished by using the approved equipment listed below or others approved by STATE:

Existing crushed rock shall be compacted and processed after completion of all project work and log hauling, unless otherwise approved in writing by STATE.

Rock shall be crowned or outsloped at 4 to 6 percent as specified in the "Forest Roads Specifications" table in Exhibit D.

ROAD SEGMENT	COMPACTION EQUIPMENT OPTIONS
All	Vibratory Roller

COMPACTION EQUIPMENT OPTIONS

Vibratory Rollers. The drum shall have a smooth surface, a diameter not less than 48 inches, a width not less than 58 inches, and a turning radius of 15 feet or less. Vibration frequency shall be regulated in steps to 1400, 1500, and 1600 VPM, corresponding to engine speeds of 1575, 1690, and 1800 RPM. The centrifugal force developed shall be 7 tons at 1600 VPM. It shall be activated by a power unit of not less than 25 horsepower. The vibratory roller shall be self-propelled and operated at speeds ranging from 0.9 miles to 1.8 miles per hour, as directed by STATE.

Tampingfoot Compactors. Tampingfoot compactors shall exert a minimum pressure of 250 pounds per square inch on the ground area in contact with the tamping feet. The compactor shall cover a minimum width of 60 inches per pass and weigh a minimum of 16,000 pounds.

Vibratory Hand-Operated or Backhoe-Mounted Tamper. Vibratory hand-held or hydraulic tampers shall be used for compaction of backfill materials around culverts (and/or bridge approach embankment materials around abutments). The tamper shoe dimensions shall be a minimum of 10" X 13" and capable of a centrifugal force of 2,250 pounds.

Crawler Tractors. A dozer/track-type tractor weighing a minimum of 45,000 pounds as directed by STATE shall be operated over the pit-run or jawrun rock so that the entire surface comes in contact with the tracks.

EXHIBIT F

ROCK QUARRY DEVELOPMENT AND USE

1. PURCHASER shall prepare a written development plan for the quarry area. The plan shall be submitted to STATE for approval prior to conducting any operation in quarry area. The plan shall include, but not be limited to:
 - (a) Location of quarry floor, benches, and roads to benches.
 - (b) Disposal site for woody debris, overburden and reject material.
 - (c) Time lines for rock quarry use.
 - (d) Erosion control measures.
 - (e) Oversize material location
2. PURCHASER shall schedule and coordinate quarry and stockpile usage with other existing or planned activity requiring quarry or stockpile usage. **PURCHASER shall notify STATE 5 days prior to the start of quarry development activities.**
3. Fall all timber within the posted right-of-way boundary and remove all merchantable timber. All woody debris, including stumps and slash shall be hauled to the designated disposal areas.
4. Where overburden removal limits have not been marked, they shall extend for a distance of at least 20 feet beyond the developed rock source. Overburden removal limits, when marked, are designated by orange right-of-way boundary tags. Overburden shall be hauled to a designated waste area. Overburden shall be spread evenly, grass seeded, and compacted at the waste area and woody debris stacked separately. Areas of overburden removal shall be inspected for completeness and approved by STATE prior to drilling or rock removal.
5. PURCHASER shall conduct the Operations relative to the disposal of waste material in such manner that silt, rock, debris, dirt, or clay shall not be washed, conveyed, or otherwise deposited in any stream. All waste shall be deposited at an approved "waste disposal site."
6. The quarry floor shall be developed to provide drainage away from the quarry. All quarry and stockpile site drainage ditches shall be developed and maintained. Drainage ditches shall not discharge into streams.
7. Benches shall be constructed and maintained at intervals of 40 feet or less in height and shall be a minimum of 20 feet in width. Any gravel or talus slopes shall be left with a working face at an angle of 60 percent or less. There shall be a minimum of one bench with an access road to it. Said bench shall be easily accessible with tractors.
8. The STATE shall be notified two working days prior to the beginning of drilling operations. Working days shall be defined as Monday through Friday, 6:00 a.m. to 2:30 p.m.
9. Controlled blasting techniques shall be utilized for any blasting operations, and shall be accomplished using timing devices, delayed charges, low intensity shots, or other suitable means to contain as much material as possible within the quarry development area (full containment). Each low intensity shot shall be shot into the previous shots' void in order to contain all the material in the quarry development area. Each shot shall also have a "tattle-tale" end cap so that it is known if all charges were detonated. The purchaser shall detonate or remove all non-detonated explosives from STATE LANDS. PURCHASER shall maintain a comprehensive blasting log that contains all pertinent data for all blasting operations. The blasting log shall be submitted to the STATE after the completion of all blasting activity. The blasting log is intended for STATE record keeping purposes only.

EXHIBIT F

ROCK QUARRY DEVELOPMENT AND USE

10. Quarry face shall be developed in a uniform manner. All quarry backslopes shall be left in a stable condition.
11. Oversized material that is produced shall be piled in the vicinity of the quarry as directed by STATE.
12. The quarry site shall be left in a condition free from overburden and debris. Access roads to the quarry, benches, and the quarry floor shall be cleared of unused shot rock and dirt at the termination of use. Access roads shall be waterbarred to provide drainage as specified in Exhibit H and blocked as directed by STATE. Unused shot rock material that is produced shall be piled in the vicinity of the quarry as directed by STATE. Dirt, overburden, and reject material shall be hauled to designated waste area.
13. Proper winterization and storm-water control measures such as waterbarring, drainage, utilization of filter bales, mulching and/or blocking access shall be constructed and maintained to protect the watershed and Project Work, as directed by STATE.
14. Apply seed and mulch to the waste area, as specified in Exhibit N.

EXHIBIT G CULVERT SPECIFICATIONS

All culvert materials shall be furnished and installed by PURCHASER, unless otherwise specified in the Contract. Culverts 30 inches in diameter and smaller shall be constructed of corrugated polyethylene. Culverts 36 inches in diameter and larger shall be constructed of corrugated aluminized Type 2 steel. Polyethylene culverts shall be double-walled and meet the requirements of AASHTO M-294-11, Type S, or ASTM F2648. Aluminized (Type 2) steel culverts shall meet the requirements of AASHTO M-36-03¹.

Lengths of individual culvert sections shall be not less than 10 feet, unless otherwise provided for in special instructions. The shortest culvert section length shall be placed at the inlet end.

Culverts 36 inches in diameter or larger shall have 1:1 beveled inlets.

Joining shall be done with bands of like material and corrugations. Manufacturers' instructions shall be followed for prefabricated pipe assembly. Polyethylene joints shall be made with split couplings, corrugated to engage the culvert corrugations, and shall engage a minimum of 4 corrugations, 2 on each side of the culvert joint.

Watertight joints with gaskets are required for all culverts 36 inches in diameter or larger. Required gasket materials shall be in accordance with the minimum requirements of the Oregon Department of Transportation Drawing RD 326, or as approved in writing by STATE.

Culverts shall be located according to the alignment and grade as shown on the Plan and Profile, and/or as staked in the field, or as specified in special instructions.

The STATE Representative shall determine final culvert locations and stake the locations in the field prior to installation.

Cross drain culverts on road grades in excess of 3 percent shall be skewed at least 30 degrees from perpendicular to the road centerline, except that cross drain culverts at the low point of dips in roads shall not be skewed.

Culvert grade shall slope away from ditch grade at least 5 percent unless otherwise specified.

The foundation and trench walls for all culverts shall be free from logs, stumps, limbs, stones, and other objects which would dent or damage the culvert. The culvert trench shall be excavated 3 culvert diameters wide to permit compaction and working on each side of the culvert. Tamping shall be done in 6-inch lifts, 1 culvert diameter each side of the culvert to 95 percent density or over. Bedrock shall be excavated as required to provide a uniform foundation for the full length of the culvert. Minimum bedding depth shall be 6 inches.

A bedding of granulated material or crushed rock as specified in Exhibit E shall be placed to provide a wide band of support and to transmit the load from above evenly over the entire length of the culvert.

Backfill shall consist of granulated material, crushed rock as specified in Exhibit E, or job-excavated soil free of stumps, limbs, rocks, or other objects which would damage the culvert.

Transporting of the culvert shall be done carefully. Dragging or allowing free fall from trucks or into trenches shall not be permitted.

Minimum height of cover over top of culvert to subgrade when road is to be rocked shall be as follows: 12" for culverts 18" to 36" in diameter and 18" for culverts 42" to 96" in diameter (add 6" for roads which will not be rocked). Minimum vertical cover for other designs shall be as specified by STATE.

The ends of each culvert shall be free of logs and debris which would restrict the free flow of water. The intake end of relief culverts shall be provided with a sediment catching basin 3 feet in diameter at the bottom. The outlet end of any culvert which would allow water to erode embankment soil shall be provided with an energy dissipator, half round, or other approved slope protection device. Construct lead-off ditches away from culvert outlets where the slope gradients restrict the free flow of water.

Tamping is required on all culverts. Backfills on culverts over 30 inches in diameter shall be compacted with a vibratory hand-operated or Backhoe mounted tamper.

EXHIBIT E

CULVERT SPECIFICATIONS

The intake end of culverts smaller than 48 inches in diameter shall be marked by installing a 5 foot long, rust-resistant painted steel fence post two feet into the ground, within 6 inches of the inlet on the downgrade side.

All culverts scheduled for replacement shall become property of the PURCHASER and shall be removed from STATE land in the same project period in which replacement occurred.

Damaged culvert inlets and/or outlets shall be repaired by opening them with a hydraulic jack or cutting off the culvert end to allow for free passage of water at peak flow levels.

A manufacturer's certification that the product was manufactured, tested, and supplied in accordance with this specification shall be furnished to STATE upon request.

Following are the minimum standard gauges for steel culvert and coupling bands. Some culverts may require different gauges and may be found in the culvert listing.

<u>Dia.</u>	<u>Steel Culvert</u>	<u>Thickness</u>		<u>Band Gauges</u>	<u>Band Widths (")</u>	
	<u>Gauge</u>	<u>Uncoated</u>	<u>Coated</u>		<u>Annular</u>	<u>Helical</u>
18-36	16	(0.0598")	(0.064")	16	12	12
48	14	(0.0747")	(0.079")	16	24	24

EXHIBIT G
CULVERT LIST

CULVERT NO.	DIAMETER (Inches)	LENGTH (Feet)	ROAD SEGMENT Point to Point	STATION
1	18	40	A to B	42+00
2*	8	30	A to B	83+80
3	18	40	A to B	88+00
4*	8	10	A to B	94+05
5	18	40	A to B	100+80
6	18	40	A to B	120+55
7	18	40	A to B	130+50
8	18	30	A to B	210+40
9*	8	10	A to B	224+10
10*	8	10	A to B	248+30
11	48	50	C to D	2+60
12	18	30	I to J	10+70
13	18	30	I to J	12+30
14	30	30	M to N	3+60
15	18	30	CC to DD	0+55
16	24	30	GG to HH	84+60
17	18	30	GG to HH	95+95

* = In ditchline for trail crossing and not across road. Single walled may be used if no double walled is available.

TOTAL LENGTHS BY DIAMETER				
8 INCH	18 INCH	24 INCH	30 INCH	48 INCH
60 Feet	350 Feet	30 Feet	30 Feet	50 Feet

EXHIBIT G

TYPICAL EMBEDDED ENERGY DISSIPATOR

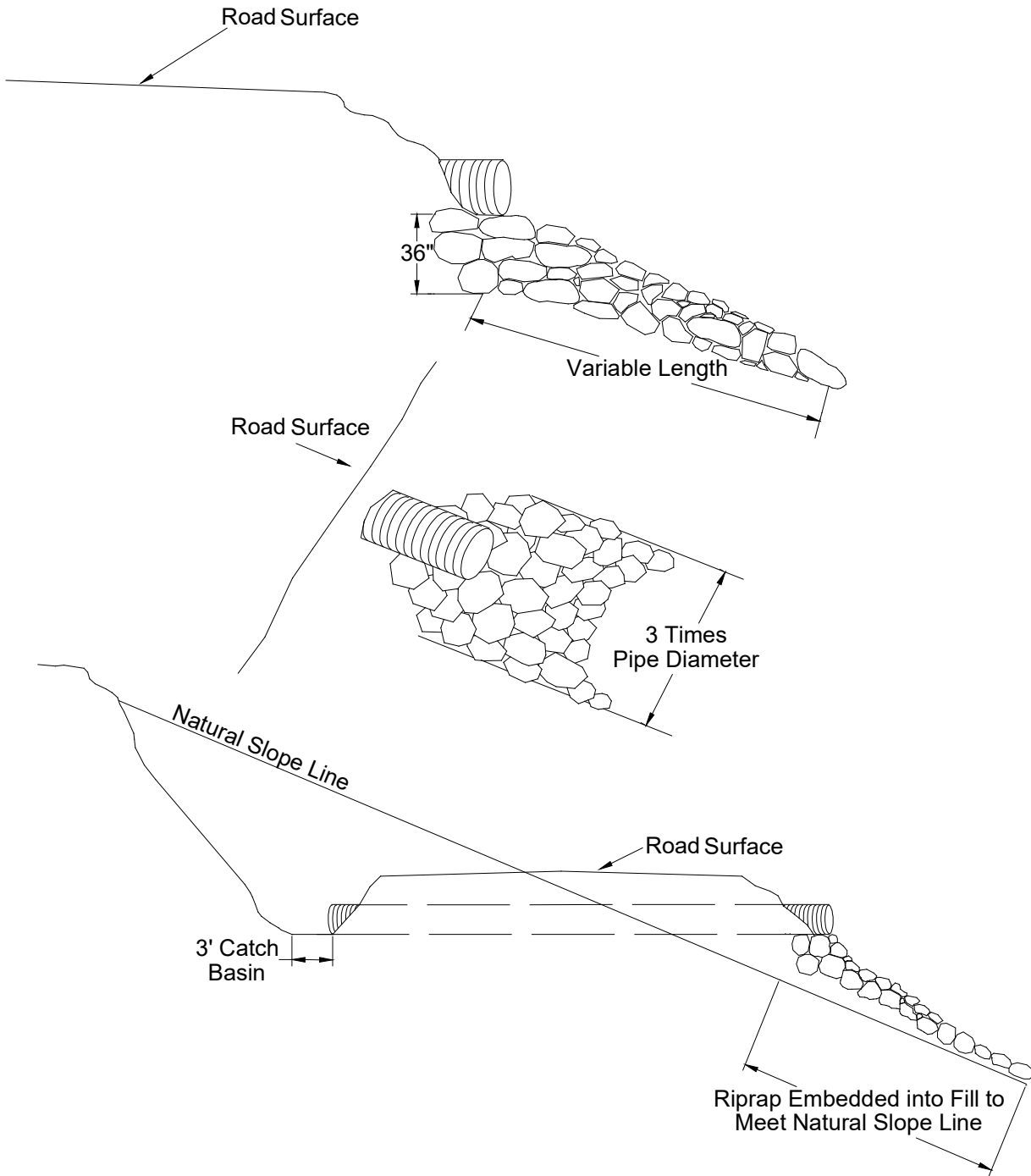
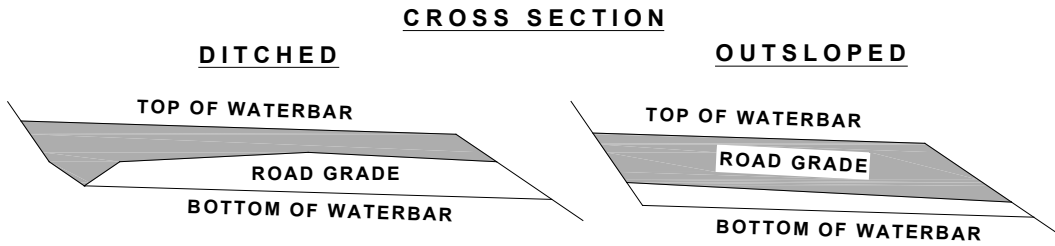
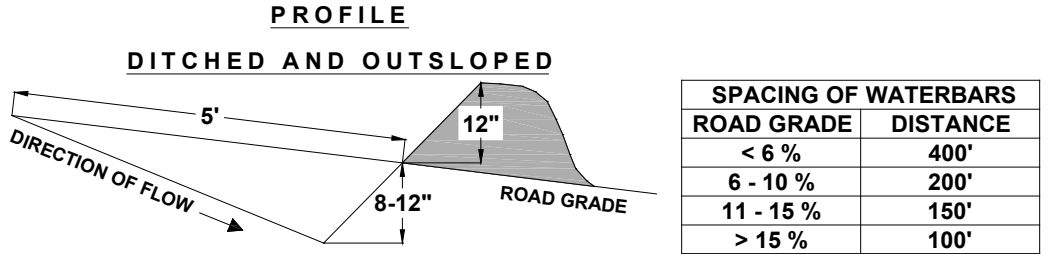

EXHIBIT H

WATERBAR SPECIFICATIONS



CONSTRUCT DITCHOUT THRU ANY EXISTING BERM.
CROSS DRAINAGE GRADIENT MINIMUM 3%.

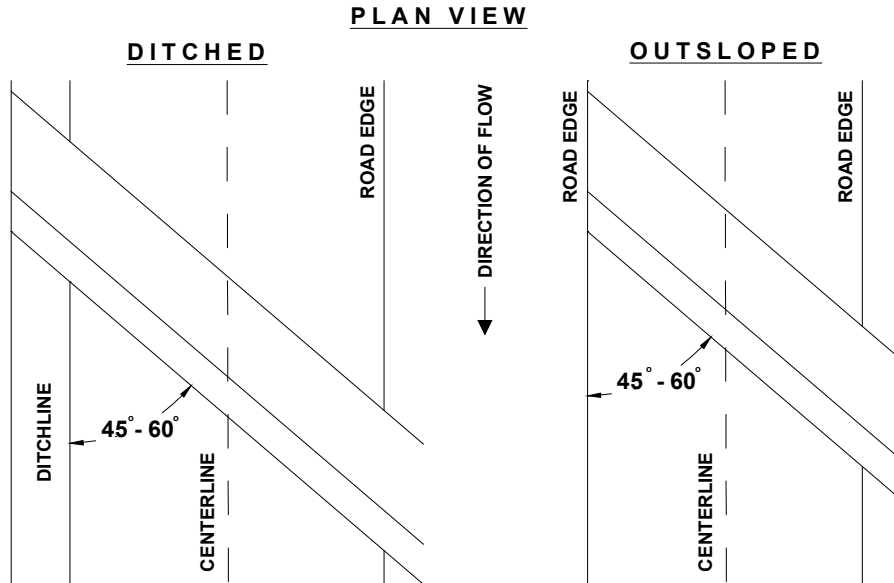
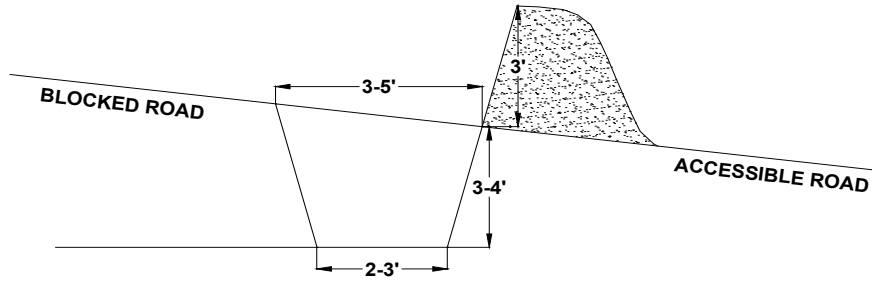
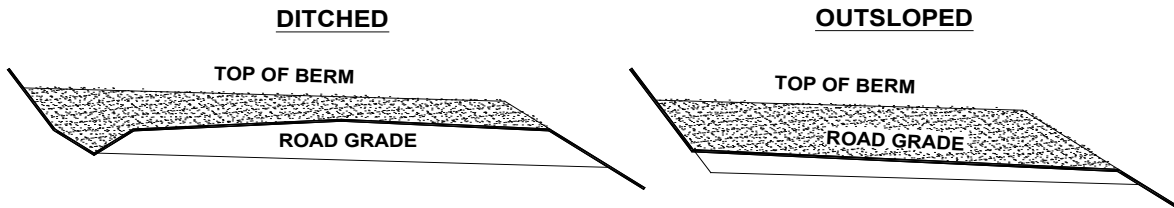

EXHIBIT I
TANK TRAP SPECIFICATIONS

**PROFILE
DITCHED AND OUTSLOPED**



CROSS SECTION



CONSTRUCT DITCHOUT THRU ANY EXISTING BERM.
CROSS DRAINAGE GRADIENT MINIMUM 3%

PLAN VIEW

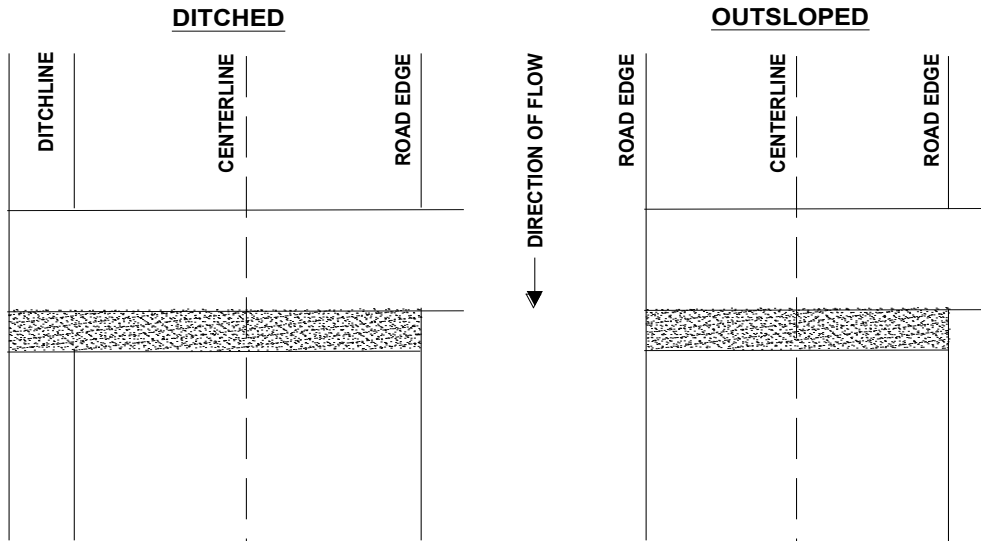

It should be sloped to drain with a relief ditch through the down slope edge of the road. The trench shall be behind the berm for approaching traffic.

EXHIBIT J
TYPICAL SIDECAST PULLBACK

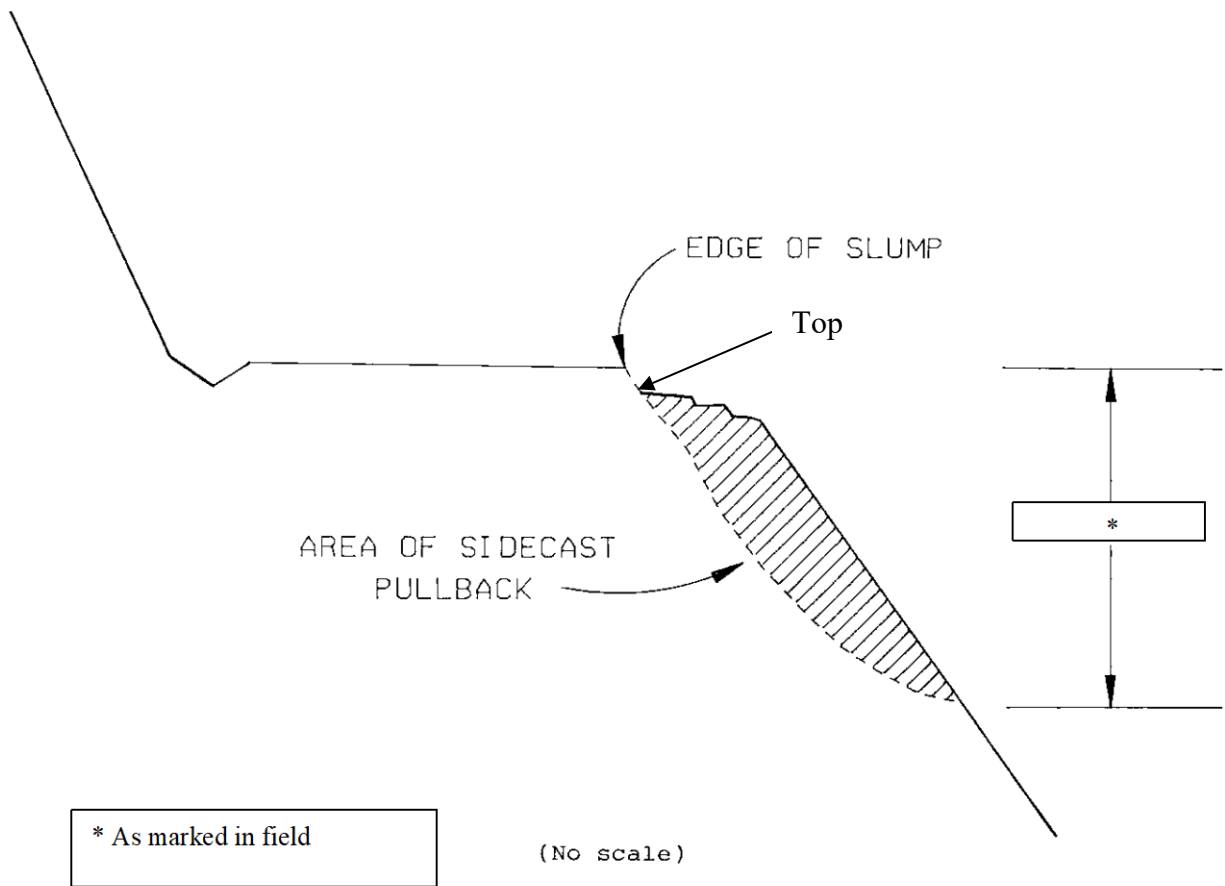

EXHIBIT L

SPECIFICATIONS FOR LANDING SLASH PILING

Piling Slash: All piles shall be as compact as possible. Piles shall be built to a height of 3 to 4 feet and then covered to prevent water from reaching the Slash. Each pile shall be covered with polyethylene plastic sheeting. State shall supply the materials used for covering the Slash. Additional woody debris shall be piled on top of the covered piles to complete the piling, as directed by STATE.

Placement of Piles: Piles shall be placed in a location to minimize damage from burning to standing green trees, snags, and culverts. Piles shall be placed as follows:

- (a) No less than 50 feet from any snag, green tree, or culvert, unless otherwise approved by STATE.
- (b) Cull log segments suitable for firewood shall be piled separately from Slash at a distance of no closer than 50 feet from the Slash piles.

EXHIBIT M

SPECIFICATIONS FOR SKID ROAD CLOSURE

All skid/forwarder roads shall be closed by PURCHASER prior to the timber sale completion.

Skid roads shall be closed by constructing a barrier which makes the road impassable to vehicular traffic. Where skid roads meet permanent forest roads, PURCHASER shall block access to vehicular traffic by placing several root wads across the road.

All berms or holes caused by logging Operations shall be flattened out to as close to the natural slope as possible.

Scatter locally available woody material (logs, stumps, brush, Slash, etc.) on the closed running surface.

Waterbar the subgrade and running surface at a spacing of no more than 100 feet and as specified in Exhibit H, "Waterbar Specifications."

Apply forage seed to the roadbed as specified in Exhibit N, "Seeding and Fertilizing."

EXHIBIT N
SEEDING AND MULCHING

SEEDING

This work shall consist of preparing seedbeds and furnishing and placing required seed.

Seeding Seasons. Seeding shall be performed only from March 1 through June 15 and August 15 through October 15. Seeding materials shall not be applied during windy weather or when the ground is excessively wet or frozen. Areas of disturbed soil shall be seeded by the end of the project period in which work was started.

Soil Preparation. Areas to be seeded that have been damaged by erosion or other causes shall be restored prior to seeding. All areas to be seeded shall be finished and then cultivated to provide a reasonably firm, but friable seedbed. A minimum of 1/2 inch of surface soil shall be in a loose condition.

Application Methods for Seed

Dry Method. Mechanical seeders, seed drills, landscape seeders, cultipacker seeders, or other approved mechanical seeding equipment shall be used to apply the seed in the amounts and mixtures specified. Hand-operated seeding devices may be used when seed is applied in dry form.

Application Rates for Seed

Seed listed below shall be applied at the following rates per acre:

SPECIES	Lb./Acre	MIXTURE	PURE LIVE SEED	Repellent
Fine Fescue	24	40%	98%	0
Annual Ryegrass	12	20%	98%	0
Perennial Ryegrass	18	30%	98%	0
White Dutch Clover	6	10%	98%	0

Seeding will be considered acceptable when all other specified requirements in Exhibit M have been completed and a healthy, uniform, close stand of grass has been established, unless otherwise approved in writing by STATE.

MULCHING

This work shall consist of furnishing and placing required mulch. Mulch shall consist of straw that is free of noxious weeds.

Mulching Period. Straw mulch shall be applied within 24 hours of spreading grass seed.

Application Rates for Mulch

Place straw mulch to a reasonably uniform thickness of 3/4 to 1 1/4 inches. This rate requires between 1 and 1 1/2 tons of dry mulch per acre.

OHV TRAIL FILTER FOR MC TRAIL

NOT TO SCALE

Blocking materials minimum size should be 3'x3', either boulders, root wads, or cull logs. Blocking materials shall be touching and extend to the edges of roadway, or skid trail.

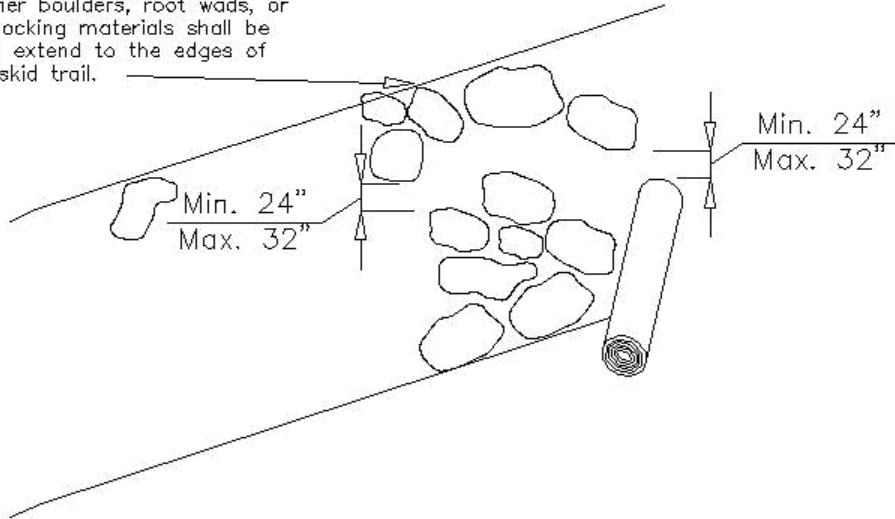

PLAN VIEW

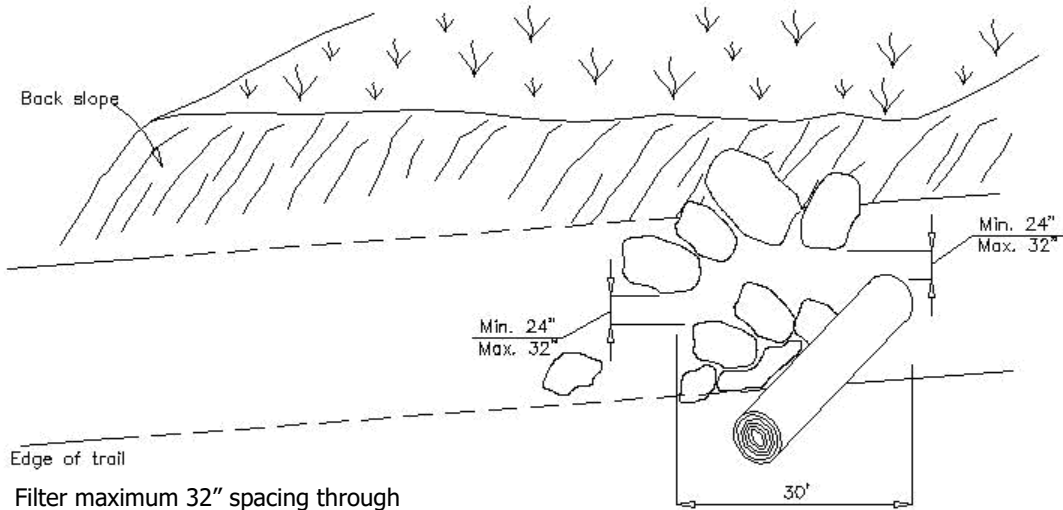

Filter maximum 32" spacing through path entrance and exit. 6'-8' curve radius through filter. Overall length of filter should be 30'. Boulders used as blocking material should be buried 1/3 of original height.

PROFILE

8 / 2005